



# The Carron Phoenix Range

---

MARCH 2023



**CARRON**  
PHOENIX

DELIVERING INSPIRATION FOR YOUR KITCHEN

The Carron Phoenix story began in 1759 when the Carron Iron Company was founded near the town of Falkirk in Central Scotland.

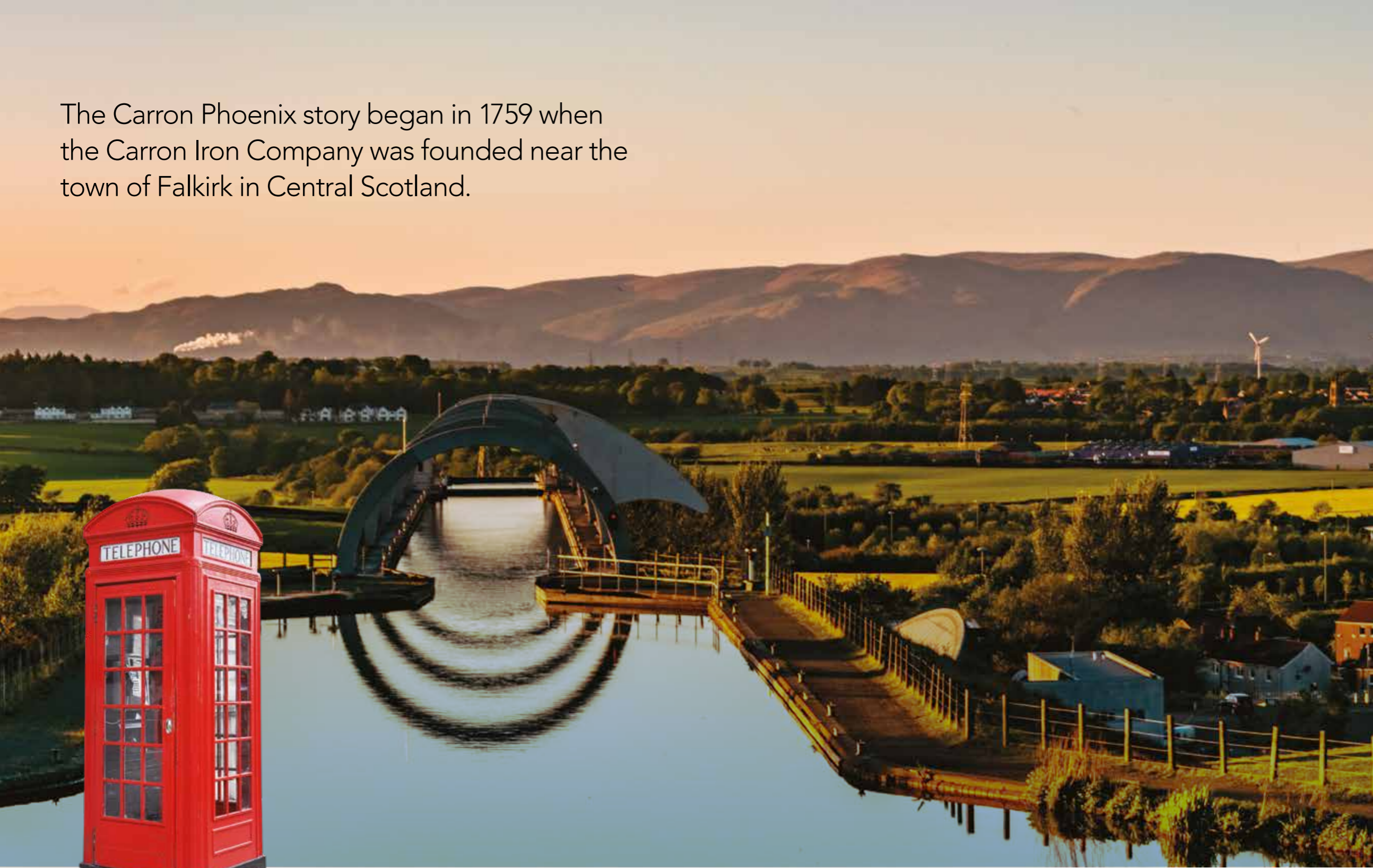

## CONTENTS

The story of Carron Phoenix	04
Choosing a sink and tap	06
Materials and finishes	07
<b>GRANITE SINKS</b>	<b>08</b>
Bali	10
Haven	11
Debut	14
<b>SYNTHETIC SINKS</b>	<b>16</b>
Janus	17
<b>STAINLESS STEEL SINKS</b>	<b>18</b>
Ibis	19
Adelphi	20
Maui	22
Zeta	24
Atoll	27
Rapid	28
Onda	30
Deca Inset / Undermount	32
Zeta Undermount	36
Ibis Undermount	37
Carisma Inset / Undermount	38
<b>CERAMIC SINKS</b>	<b>39</b>
Sienna	40
Shonelle	41
Belfast	42
Carlow	44
Waterford Inset / Undermount	45
<b>TAPS</b>	<b>46</b>
Seraphina Boiling Water Tap	47
Filter Taps	48
Mixer Taps	50
<b>WASTE MANAGEMENT</b>	<b>56</b>
Carronade Elite WDUs	57
Linea Waste Sorter Bins	57

Famed for the manufacture of the iconic red telephone boxes and pillar boxes still in use throughout the UK today, the Carron Iron Company was considered to be the centre of the industrial revolution in Scotland and quickly became the largest iron works in Europe.

Moving forward more than 250 years Carron Phoenix is now one of the leading manufacturers of kitchen sinks in the UK. Our sink design philosophy means that we do not compromise between stylish good looks and practicality. Whether Granite, Stainless Steel or Ceramic, all of our sinks are guaranteed for a lifetime, so you can be confident that they are of exceptional quality and are made to last.

To complement the perfect sink, our extensive range of taps, accessories and waste management systems, gives you an all-round solution for getting the most from your kitchen sink space. Carron Phoenix manufactures products that are beautiful to look at and excellent to work with.



## GUARANTEES

As Carron Phoenix sinks are built to the highest manufacturing standards, we are proud to offer an extensive guarantee on all of our products against manufacturing defects.

Full details of our guarantees can be found on: [www.carron.com/guarantee](http://www.carron.com/guarantee)

-  Two year guarantee for accessories
-  Two year guarantee on instant boiling water taps
-  Five year guarantee for standard taps
-  Lifetime guarantee for sinks

# The story of Carron Phoenix



“ Our sink and tap collections bring together a choice of designs and materials to suit the diversity of today’s kitchen styling. It’s not just about good looks, it’s also about what works for you. From classic to contemporary, our products combine design inspiration and practicality.



Carron Iron Company founded near Falkirk in

**1759**

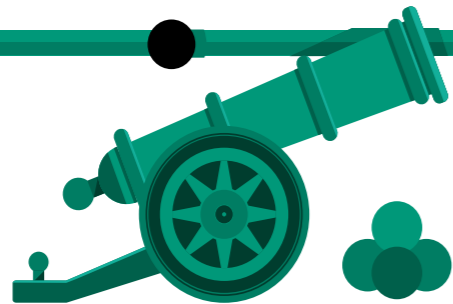

Carron Iron Company produces first cannons

**1776**

Moving into Sink manufacture

*Esto Perpetua*

**1774** (“Ever lasting”) motto is introduced

**1814**

Carron becomes Europe’s biggest Iron Works

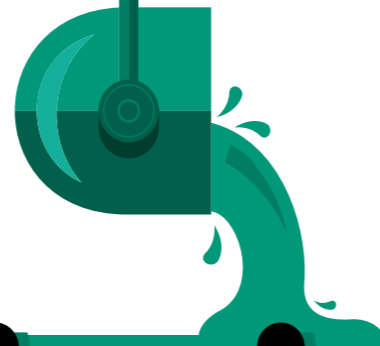

**1920**

Carron Iron Company starts producing telephone and pillar boxes

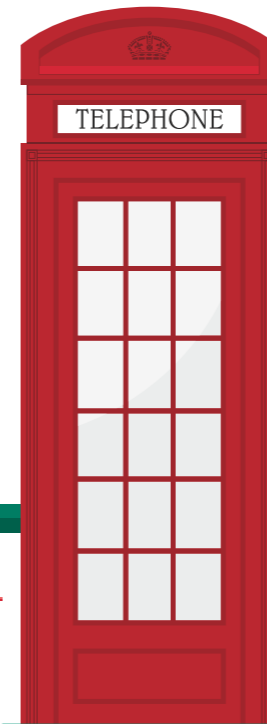

**1960**

Carron begins Stainless Steel Sink production

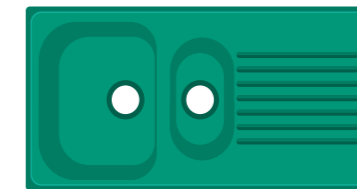

**1991**

Carron Range extends to Taps and Accessories.  
2007 includes Waste Management Systems  
2013 Introduces Instant Boiling Water Tap

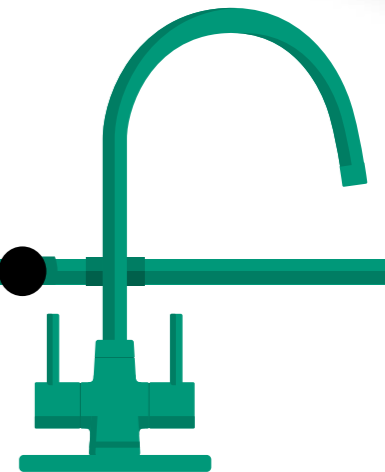

## Choosing a sink

There are a number of factors to consider when choosing your kitchen sink; functionality is just as important as design, and here is a short guide to the initial decisions you will need to make before choosing the right model for you and your kitchen.

### Sink configurations and cabinet size

Whether you prefer the larger capacity of a single bowl or the versatility offered by a one and a half bowl sink, there are options to suit. The following symbols are used throughout this brochure as a guide.



**Left hand drainer:**  
The drainer is to the left of the main bowl.



**Right hand drainer:**  
The drainer is to the right of the main bowl.

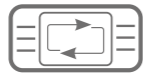

**Reversible drainer:**  
The sink has tap holes front and back to allow the sink to be fitted with the drainer to the left or the right.



**Left hand 1/2 bowl:**  
For sinks without a drainer but multiple bowls. Indicates the small bowl is to the left of the main bowl.



**Right hand 1/2 bowl:**  
For sinks without a drainer but multiple bowls. Indicates the small bowl is to the right of the main bowl.



#### Inset

Inset sinks are mounted from above, and the edge of the sink sits on top of the worktop. This is the most standard type of installation and can be used with all worktop types, including laminate worktops. Inset sinks generally have a drainer board and are available in a wide range of styles and materials to suit your preference.



#### Undermount

When your worktop is made from a solid-surface material, such as granite, solid wood or engineered stone, you have the option of choosing an undermounted sink. This style is installed from beneath the work surface and allows for a clean minimalist look to the kitchen. Drainer grooves are often cut into the work surface to complete the elegant look.

It is essential to check the cabinet size of your kitchen to ensure that the sink will fit. Throughout the brochure, 'Min Cabinet' indicates the minimum cabinet size (measured left-to-right) required to allow the sink to fit.

## Choosing a tap

Throughout our brochure we offer a wide choice of sinks to suit all tastes. Each of these sinks is shown with a Henley tap. However, if you would like to upgrade your tap to your choice and specification, please refer to pages 46-55 for our full range.



**Perlator:** Mixes air into the flow of water to give a champagne-like flow.

## Materials and finishes

Kitchen sinks are available in a range of materials to suit your particular requirements and design preferences. Whichever material you choose, you can rest assured that your Carron Phoenix sink is manufactured to the highest standards.



**Stainless Steel** is available in **P** **B**

An established favourite, stainless steel sinks are practical, hard-wearing and easy to clean. Available in polished or brushed finishes.



**Granite** is available in **PW** **CO** **SG** **ON** **MB**

Manufactured using real granite particles, this material gives you the design flexibility to introduce colour into your sink area and offers exceptional performance for the life of your kitchen.



**Synthetic** is available in **AW** **GP**

Using a newly-developed proprietary coating, our synthetic sinks offer excellent heat, shock and impact resistance at a value-for-money price level.



**Ceramic** is available in **WH**

Whether your kitchen design is traditional or contemporary, the lustre of a fine-fireclay ceramic sink will add a touch of elegance.

# GRANITE

A beautifully tactile material which allows you to make a real statement in your kitchen.

The versatility of granite allows Carron Phoenix to create a range of designs which combine form and function perfectly.

Bali 100 in Polar White with Bali tap in Chrome

Each Carron Phoenix sink is supported by a **Lifetime Guarantee** against manufacturing defects



# Choice of colours

Our granite sinks come in a choice of classic and contemporary neutrals, that offer superb design scope for combining with a wide range of work surface materials. Some of our colours contain metallic particles for a beautifully subtle, but rich appearance.

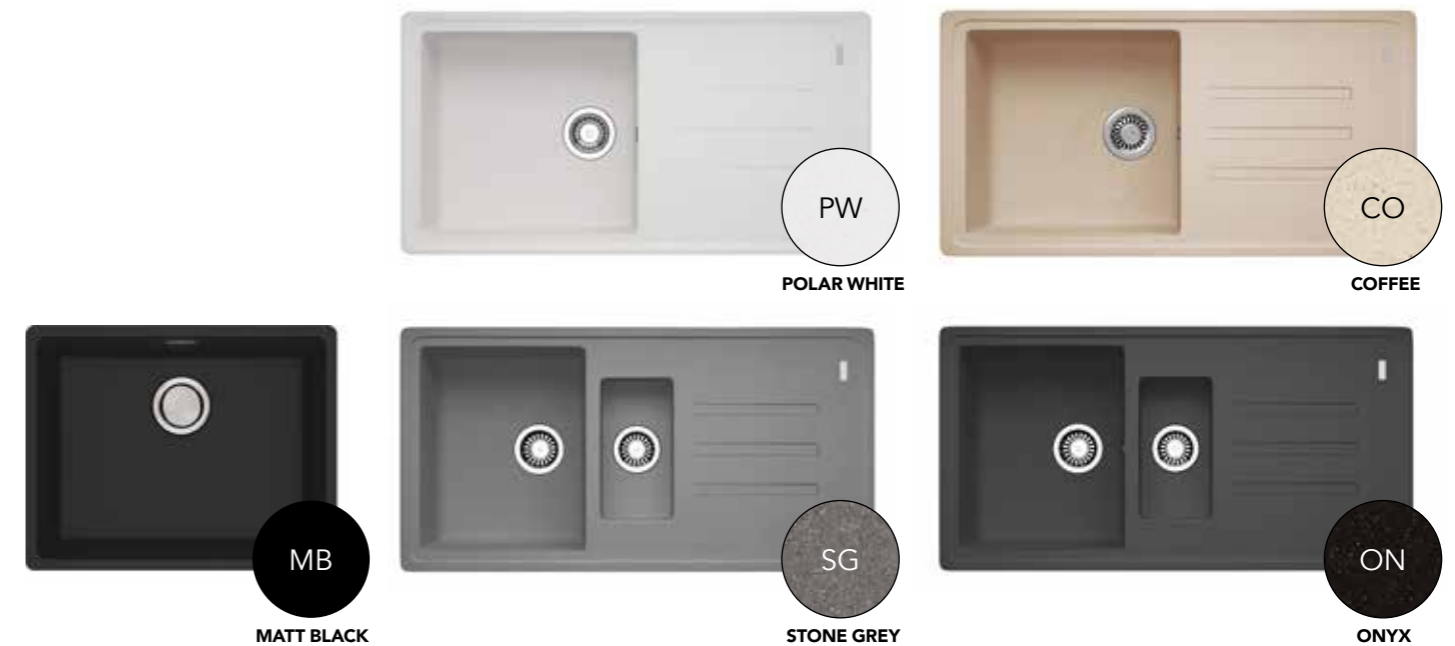

No other kitchen sink material offers the durability and hard-wearing properties of Carron Phoenix Granite. We use real Granite particles – the fourth hardest material known to man as the main component of every sink.

Scratch resistant, stain resistant, temperatureresistant to 280oC and easy to clean, Carron Phoenix Granite sinks will retain their great looks for a lifetime.

When you're looking for a beautiful and hard working sink, granite is the ultimate choice. Furthermore, each Carron Phoenix sink is supported by a Lifetime Guarantee against manufacturing defects.



**YOU CAN'T SCRATCH IT**  
Knives and forks won't mark or score the surface.



**YOU CAN'T SCORCH IT**  
Even at 280°C the surface will not burn.



**YOU CAN'T STAIN IT**  
Carron Granite sinks are highly resistant to staining, marking and fading.



**EASY TO CLEAN**  
Carron Granite sinks are now 30% smoother than before and even easier to keep clean.



**SANITIZED®**  
Silver ions embedded in the Granite prevent 99% of bacteria multiplying.



## Sanitized®

Kitchens can be a critical location for the spreading of bacteria and on unprotected materials, bacteria can multiply every twenty minutes and have a negative effect on hygiene.

The integrated Sanitized® hygiene function in each Carron Phoenix Granite sink helps to keep your sink area clean and provides your sink with lasting protection.

Sanitized® silver ions are embedded into our Granite offering you long-term protection. Silver is an active ingredient that prevents microbes and bacteria from multiplying and tests have proven that Carron Phoenix Granite treated with Sanitized® reduces bacteria and microbe growth by 99%.

The silver ions embedded within Carron Phoenix Granite destabilise any bacteria cell membranes, impeding their respiration and food intake as well as inhibiting cell division.

Sanitized® helps to keep the surface protected from bacteria and microbe growth after and in-between cleaning, and helps to reduce the risk of transferring bacteria and microbes from the sink surface to food or other objects. The biocidal substance locates bacteria via moisture on the surface and then deactivates it, reducing its growth and multiplication by 99%.



The silver ion locates bacteria via moisture and deactivates it

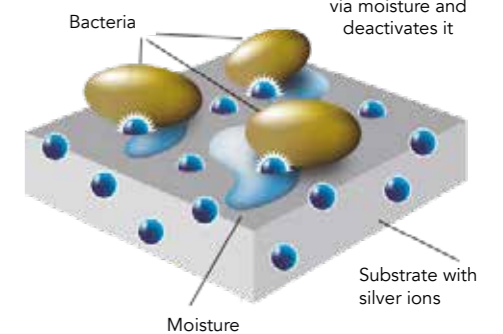

Active biocidal substance: silver phosphate glass

# BALI

Bali brings a superb combination of style and grace to any kitchen space following the 'less is more' rule of styling. Available in two models and complemented by a range of modern yet practical accessories. Bali offers both simplicity and functionality for any busy kitchen.

Sinks shown with Henley tap  
Henley tap Chrome - 115.0254.448

## Bali 105

Shown in Onyx

Pack RRP **£727**  
Sink only RRP **£520**



- PW 114.0055.859
- SG 114.0055.863
- ON 114.0159.244

DIMENSIONS	Left to Right: 970mm Front to Back: 500mm
BOWL DIMENSIONS	Left to Right: 460mm Front to Back: 390mm
BOWL DEPTH	190mm
CUT OUT DIMENSIONS	Left to Right: 950mm Front to Back: 480mm
CORNER RADIUS	20mm
MINIMUM CABINET	600mm

OTHER – Suitable for WDU – Yes  
Revolution Waste included

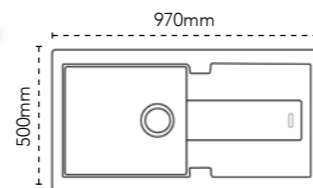

## Bali 150

Shown in Polar White

Pack RRP **£774**  
Sink only RRP **£567**



- PW 114.0055.862
- SG 114.0055.865
- ON 114.0159.252

### ACCESSORIES £91 - 112.0067.976



DIMENSIONS	Left to Right: 970mm Front to Back: 500mm
1ST BOWL DIMENSIONS	Left to Right: 350mm Front to Back: 390mm
2ND BOWL DIMENSIONS	Left to Right: 160mm Front to Back: 320mm
BOWL DEPTH	190mm / 120mm
CUT OUT DIMENSIONS	Left to Right: 950mm Front to Back: 480mm
CORNER RADIUS	20mm
MINIMUM CABINET	600mm

OTHER – Suitable for WDU – In main bowl only  
Revolution Waste included

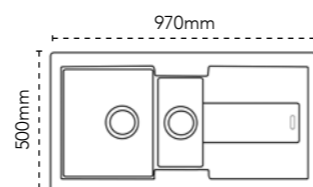

# HAVEN

Haven opens up the design potential for undermounting Granite sinks into a wide range of work surface materials. With its choice of beautifully neutral tones and contemporary shades, Haven offers an appealing and high performance alternative to Stainless Steel.

Sinks shown with Henley tap  
Henley tap Chrome - 115.0254.448

## Haven 90

NEW

Shown in Polar White

Pack RRP **£607**  
Sink only RRP **£400**



- PW 125.0696.027
- SG 125.0696.028
- MB 125.0696.026
- CO 125.0696.029

DIMENSIONS	Left to Right: 403mm Front to Back: 433mm
BOWL DIMENSIONS	Left to Right: 370mm Front to Back: 400mm
BOWL DEPTH	200mm
CUT OUT DIMENSIONS	Use template
MINIMUM CABINET	450mm

OTHER – Suitable for WDU – Yes  
Revolution Waste included

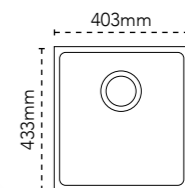

Haven 150 -16  
in Polar White  
with Sift Filter tap  
in Chrome



Haven 100  
in Stone Grey  
with Dante tap  
in Chrome

Sinks shown with Henley tap  
Henley tap Chrome - 115.0254.448

**Haven 100** NEW

Shown in Stone Grey

Pack RRP **£657**  
Sink only RRP **£450**

- PW 125.0696.031
- SG 125.0696.032
- MB 125.0696.030
- CO 125.0696.033



ACCESSORY **£40** - 112.0018.988



DIMENSIONS	Left to Right: 553mm Front to Back: 433mm
BOWL DIMENSIONS	Left to Right: 520mm Front to Back: 400mm
BOWL DEPTH	200mm
CUT OUT DIMENSIONS	Use template
MINIMUM CABINET	600mm

OTHER – Suitable for WDU – Yes  
Revolution Waste included

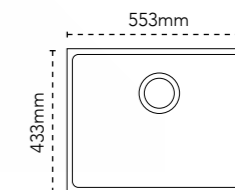

**Haven 150-16** NEW

Shown in Coffee

Pack RRP **£707**  
Sink only RRP **£500**



- PW 125.0696.035
- SG 125.0696.036
- MB 125.0696.034
- CO 125.0696.037



ACCESSORY **£40** - 112.0018.988



DIMENSIONS	Left to Right: 553mm Front to Back: 433mm
1ST BOWL DIMENSIONS	Left to Right: 340mm Front to Back: 400mm
2ND BOWL DIMENSIONS	Left to Right: 150mm Front to Back: 400mm
BOWL DEPTH	200mm/150mm
CUT OUT DIMENSIONS	Use template
MINIMUM CABINET	600mm

OTHER – Suitable for WDU – In main bowl only  
Revolution Waste included

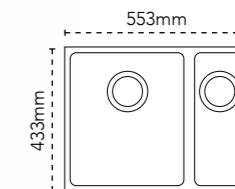

**Upgrade  
to your  
ideal tap!**

See our taps range  
on pages 46 - 55

# DEBUT



Our Debut range offers a modern touch to a classic design, with soft drainer grooves and gentle corners, this sink offers a great deal of functionality. Available in three models and each complemented by a range of accessories, Debut is a hard-working addition to your kitchen.

Upgrade to your ideal tap!

See our taps range on pages 46 - 55

Upgrade to your ideal tap!

See our taps range on pages 46 - 55

Sinks shown with Henley tap  
Henley tap Chrome - 115.0254.448

Sinks shown with Henley tap  
Henley tap Chrome - 115.0254.448

## Debut 100

Shown in Stone Grey

Pack RRP **£645**  
Sink only RRP **£438**



- PW 114.0201.152
- SG 114.0252.361
- ON 114.0252.349
- CO 114.0201.150

ACCESSORY **£40** - 112.0018.988



DIMENSIONS	Left to Right: 780mm Front to Back: 500mm
BOWL DIMENSIONS	Left to Right: 340mm Front to Back: 420mm
BOWL DEPTH	200mm
CUT OUT DIMENSIONS CORNER RADIUS	Left to Right: 760mm Front to Back: 480mm 20mm
MINIMUM CABINET	500mm

OTHER – Suitable for WDU – Yes  
Standard Waste included

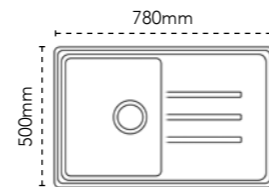

ACCESSORY **£40** - 112.0018.988



DIMENSIONS	Left to Right: 970mm Front to Back: 500mm
1ST BOWL DIMENSIONS	Left to Right: 450mm Front to Back: 420mm
BOWL DEPTH	200mm
CUT OUT DIMENSIONS CORNER RADIUS	Left to Right: 950mm Front to Back: 480mm 20mm
MINIMUM CABINET	600mm

OTHER – Suitable for WDU – Yes  
Standard Waste included

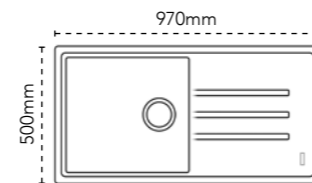

## Debut 105

Shown in Polar White

Pack RRP **£664**  
Sink only RRP **£457**



- PW 114.0288.187
- SG 114.0288.192
- ON 114.0288.193

## Debut 150

Shown in Onyx

Pack RRP **£677**  
Sink only RRP **£470**



- PW 114.0201.155
- SG 114.0252.436
- ON 114.0252.432
- CO 114.0201.153

ACCESSORIES **£93** - 112.0255.467



DIMENSIONS	Left to Right: 970mm Front to Back: 500mm
1ST BOWL DIMENSIONS	Left to Right: 340mm Front to Back: 420mm
2ND BOWL DIMENSIONS	Left to Right: 150mm Front to Back: 290mm
BOWL DEPTH	200mm /100mm
CUT OUT DIMENSIONS CORNER RADIUS	Left to Right: 950mm Front to Back: 480mm 20mm
MINIMUM CABINET	600mm

OTHER – Suitable for WDU – Yes  
Standard Waste included

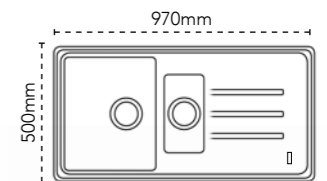



# JANUS

The Janus range of synthetic sinks offer great value and have a durable coating ensuring it is a hardworking sink; available in either Arctic White or Graphite colour options.

**Upgrade to your ideal tap!**

See our taps range on pages 46 - 55

Sinks shown with Henley tap  
Henley tap Chrome - 115.0254.448



Janus 100 in Arctic White with Zeno tap in Chrome

## Janus 100

Shown in Arctic White

Pack RRP **£430**  
Sink only RRP **£223**



AW 114.0308.256

GP 114.0308.260

DIMENSIONS	Left to Right: 970mm Front to Back: 500mm
BOWL DIMENSIONS	Left to Right: 450mm Front to Back: 420mm
BOWL DEPTH	200mm
CUT OUT DIMENSIONS	Left to Right: 950mm Front to Back: 480mm
MINIMUM CABINET	600mm

OTHER – Suitable for WDU – Yes  
Standard Waste included

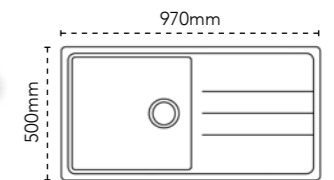

## SYNTHETIC

Using a newly developed proprietary coating, our Synthetic sinks offer excellent heat, shock and impact resistance as well as exceptional value for money.

The Carron Phoenix Synthetic sinks are available in a choice of two colours to suit your kitchen design.



Each Carron Phoenix sink is supported by a **Lifetime Guarantee** against manufacturing defects.



## Janus 150

Shown in Graphite

Pack RRP **£459**  
Sink only RRP **£252**



AW 114.0308.263

GP 114.0308.264

DIMENSIONS	Left to Right: 970mm Front to Back: 500mm
1ST BOWL DIMENSIONS	Left to Right: 340mm Front to Back: 420mm
2ND BOWL DIMENSIONS	Left to Right: 150mm Front to Back: 290mm
BOWL DEPTH	200mm/100mm
CUT OUT DIMENSIONS	Left to Right: 950mm Front to Back: 480mm
MINIMUM CABINET	600mm

OTHER – Suitable for WDU – In main bowl only  
Standard Waste included

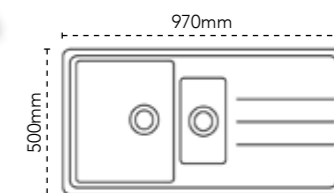

# STAINLESS STEEL

Stainless Steel is the professional's favourite. You can wash and buff it and over time it will develop a beautiful patina. Even with years of rigorous use, Stainless Steel maintains the good looks that have made this material such a popular choice.

All of our sinks are made from high quality Stainless Steel, ensuring their lasting quality and performance.

Practical, stylish and always of the highest quality, it's easy to find the right design for your kitchen within our extensive range of Stainless Steel sinks.



Each Carron Phoenix sink is supported by a **Lifetime Guarantee** against manufacturing defects.

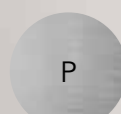

POLISHED

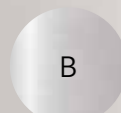

BRUSHED



Ibis 150 with Dante tap in Chrome

# IBIS

The appeal of Ibis lies in its absolute simplicity. The inset models have low-profile edges, giving an almost seamless finish with the work surface. Clean lines and contemporary styling are echoed throughout the Ibis range, from the drainer pattern to the ergonomic bowl options that are deeper than the average sink.

Sinks shown with Henley tap  
Henley tap Chrome - 115.0254.448

Upgrade to your ideal tap!

See our taps range on pages 46 - 55

## Ibis 100

Shown in Polished Stainless Steel

Pack RRP **£630**

Sink only RRP **£423**

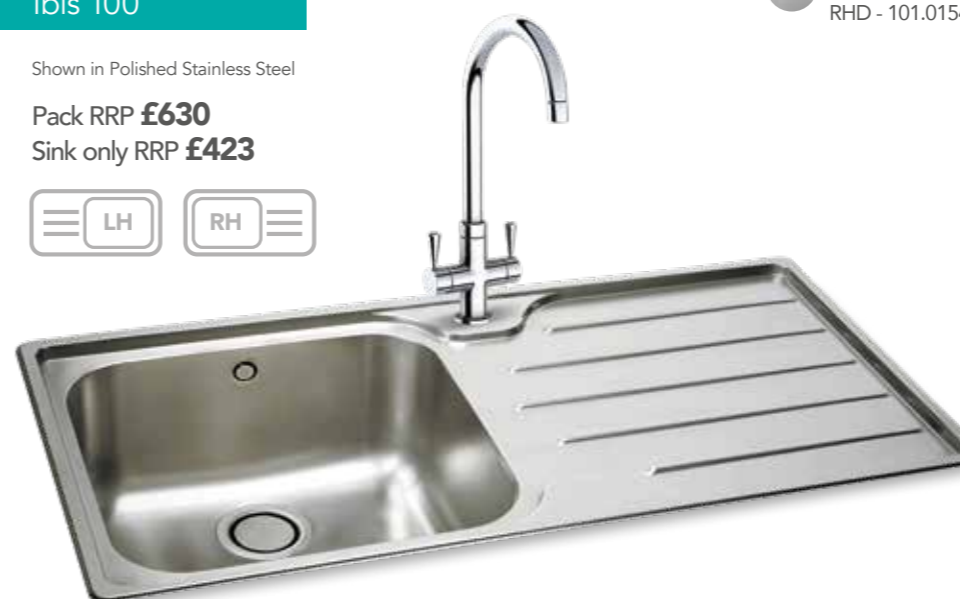

P LHD - 101.0155.229  
RHD - 101.0154.519

DIMENSIONS	Left to Right: 1030mm Front to Back: 510mm
BOWL DIMENSIONS	Left to Right: 450mm Front to Back: 420mm
BOWL DEPTH	200mm
CUT OUT DIMENSIONS	Left to Right: 1014mm Front to Back: 494mm
MINIMUM CABINET	600mm

OTHER - Suitable for WDU - Yes  
Revolution Waste included

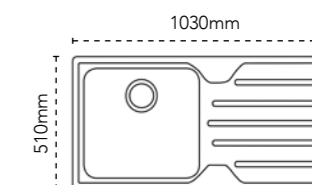

## Ibis 150

Shown in Polished Stainless Steel

Pack RRP **£722**

Sink only RRP **£515**

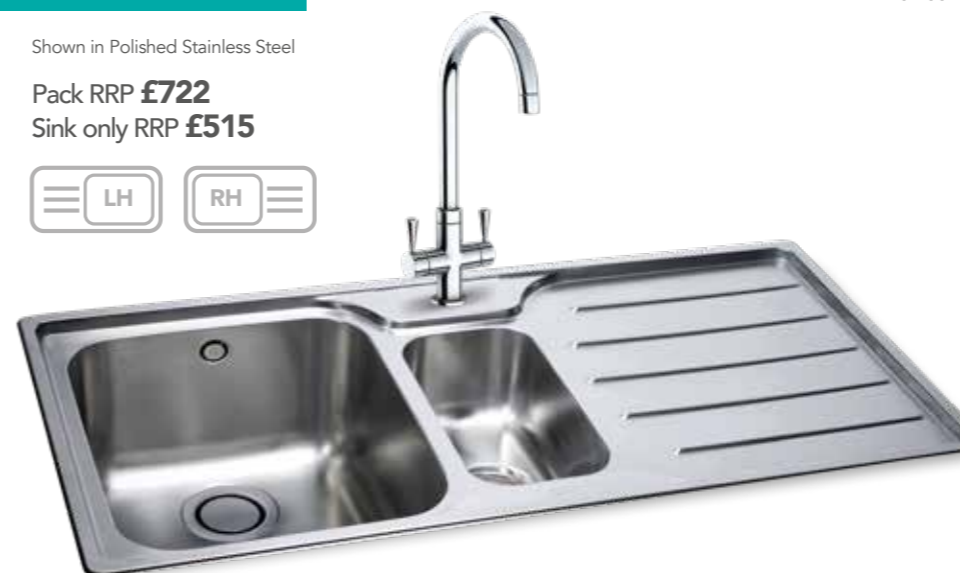

P LHD - 101.0042.891  
RHD - 101.0042.910

DIMENSIONS	Left to Right: 1030mm Front to Back: 510mm
1ST BOWL DIMENSIONS	Left to Right: 450mm Front to Back: 420mm
2ND BOWL DIMENSIONS	Left to Right: 170mm Front to Back: 320mm
BOWL DEPTH	200mm/130mm
CUT OUT DIMENSIONS	Left to Right: 1014mm Front to Back: 494mm
MINIMUM CABINET	600mm

OTHER - Suitable for WDU - In main bowl only  
Revolution Waste included

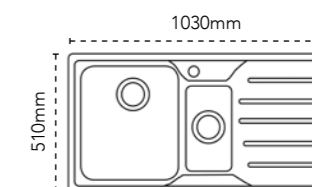

# ADELPHI

Boasting an ultra-slim, flush-fit edge profile, Adelphi is a sink that melts almost seamlessly into your work surface, offering an impeccably minimalist appearance. Whether you choose the single or 1.5 bowl option, Adelphi's contemporary and sleek design will remain stylish for years to come.

Sinks shown with Henley tap  
Henley tap Chrome - 115.0254.448

Upgrade  
to your  
ideal tap!

See our taps range  
on pages 46 - 55

## Adelphi 100

Shown in Polished Stainless Steel

Pack RRP **£578**  
Sink only RRP **£371**



P 127.0285.738

DIMENSIONS	Left to Right: 940mm Front to Back: 510mm
BOWL DIMENSIONS	Left to Right: 360mm Front to Back: 420mm
BOWL DEPTH	200mm
CUT OUT DIMENSIONS	Left to Right: 924mm Front to Back: 494mm
MINIMUM CABINET	500mm

OTHER – Suitable for WDU – Yes  
Revolution Waste included

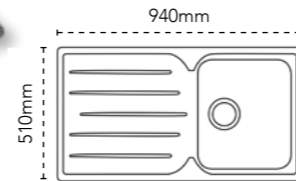

## Adelphi 150

Shown in Polished Stainless Steel

Pack RRP **£654**  
Sink only RRP **£447**



P 127.0285.739

DIMENSIONS	Left to Right: 1030mm Front to Back: 510mm
1ST BOWL DIMENSIONS	Left to Right: 360mm Front to Back: 420mm
2ND BOWL DIMENSIONS	Left to Right: 170mm Front to Back: 320mm
BOWL DEPTH	200mm / 130mm
CUT OUT DIMENSIONS	Left to Right: 1014mm Front to Back: 494mm
MINIMUM CABINET	600mm

OTHER – Suitable for WDU – In main bowl only  
Revolution Waste included

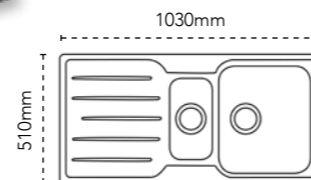

Adelphi 150 with Seraphina tap in Chrome

# MAUI

The Maui range succeeds in combining soft organic design with precise and contemporary angles. Maui is perfect if you want to make a unique design statement, whilst maintaining the best of Carron Phoenix practicality.

Sinks shown with Henley tap  
Henley tap Chrome - 115.0254.448

## Maui 90

Shown in Polished Stainless Steel

Pack RRP **£514**  
Sink only RRP **£307**



P LHD - 101.0155.116  
RHD - 101.0155.119

DIMENSIONS	Left to Right:	900mm
	Front to Back:	500mm
BOWL DIMENSIONS	Left to Right:	370mm
	Front to Back:	400mm
BOWL DEPTH		200mm
CUT OUT DIMENSIONS	Left to Right:	884mm
	Front to Back:	484mm
MINIMUM CABINET		500mm

OTHER – Suitable for WDU – Yes  
Revolution Waste included

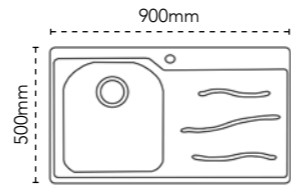

## Maui 150

Shown in Polished Stainless Steel

Pack RRP **£626**  
Sink only RRP **£419**



P LHD - 101.0155.121  
RHD - 101.0155.124

DIMENSIONS	Left to Right:	1030mm
	Front to Back:	500mm
1ST BOWL DIMENSIONS	Left to Right:	370mm
	Front to Back:	400mm
2ND BOWL DIMENSIONS	Left to Right:	160mm
	Front to Back:	360mm
BOWL DEPTH		200mm/130mm
CUT OUT DIMENSIONS	Left to Right:	1014mm
	Front to Back:	484mm
MINIMUM CABINET		600mm

OTHER – Suitable for WDU – In main bowl only  
Revolution Waste included

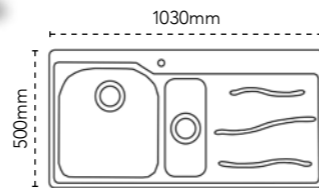

Upgrade  
to your  
ideal tap!

See our taps range  
on pages 46 - 55

Maui 150  
with Bali Tap  
in Chrome



# ZETA

Zeta's modern design combines straight lines with soft curves and the low profile perimeter gives added design appeal. Available in three inset models, Zeta is user-friendly with spacious bowls and practical accessories.

Sinks shown with Henley tap  
Henley tap Chrome - 115.0254.448

**Upgrade  
to your  
ideal tap!**

See our taps range  
on pages 46 - 55

## Zeta 90

Shown in Polished Stainless Steel

Pack RRP **£493**  
Sink only RRP **£286**



P 101.0153.943

DIMENSIONS	Left to Right: 940mm Front to Back: 510mm
BOWL DIMENSIONS	Left to Right: 360mm Front to Back: 420mm
BOWL DEPTH	180mm
CUT OUT DIMENSIONS	Left to Right: 924mm Front to Back: 494mm
MINIMUM CABINET	500mm

OTHER – Suitable for WDU – Yes  
Standard Waste included

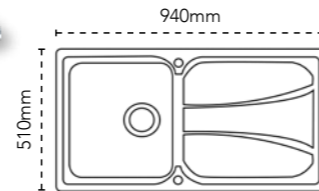

## Zeta 100

Shown in Polished Stainless Steel

Pack RRP **£510**  
Sink only RRP **£303**



P 101.0043.154

DIMENSIONS	Left to Right: 1030mm Front to Back: 510mm
BOWL DIMENSIONS	Left to Right: 450mm Front to Back: 420mm
BOWL DEPTH	180mm
CUT OUT DIMENSIONS	Left to Right: 1014mm Front to Back: 494mm
MINIMUM CABINET	600mm

OTHER – Suitable for WDU – Yes  
Standard Waste included

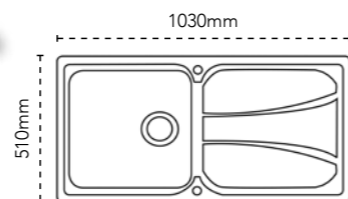

Zeta 100  
with Bali tap  
in Chrome



## Zeta 150

Shown in Polished Stainless Steel

Pack RRP **£634**  
Sink only RRP **£427**

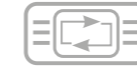

P 101.0153.952

DIMENSIONS	Left to Right: 1030mm Front to Back: 510mm
1ST BOWL DIMENSIONS	Left to Right: 360mm Front to Back: 420mm
2ND BOWL DIMENSIONS	Left to Right: 170mm Front to Back: 320mm
BOWL DEPTH	180mm/130mm
CUT OUT DIMENSIONS	Left to Right: 1014mm Front to Back: 484mm
MINIMUM CABINET	600mm

OTHER – Suitable for WDU – In main bowl only  
Revolution Waste included

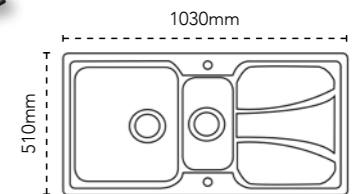



Atoll 150  
with Sift Filter tap  
in Chrome

## ATOLL

The Atoll Stainless Steel inset sinks are appealing to all kitchen types. With their generously large bowls and crisp drainer grooves, these sinks are both stylish and practical at the same time!

Sinks shown with Henley tap  
Henley tap Chrome - 115.0254.448

**Upgrade  
to your  
ideal tap!**

See our taps range  
on pages 46 - 55

### Atoll 90

Shown in Polished Stainless Steel

Pack RRP **£455**  
Sink only RRP **£248**

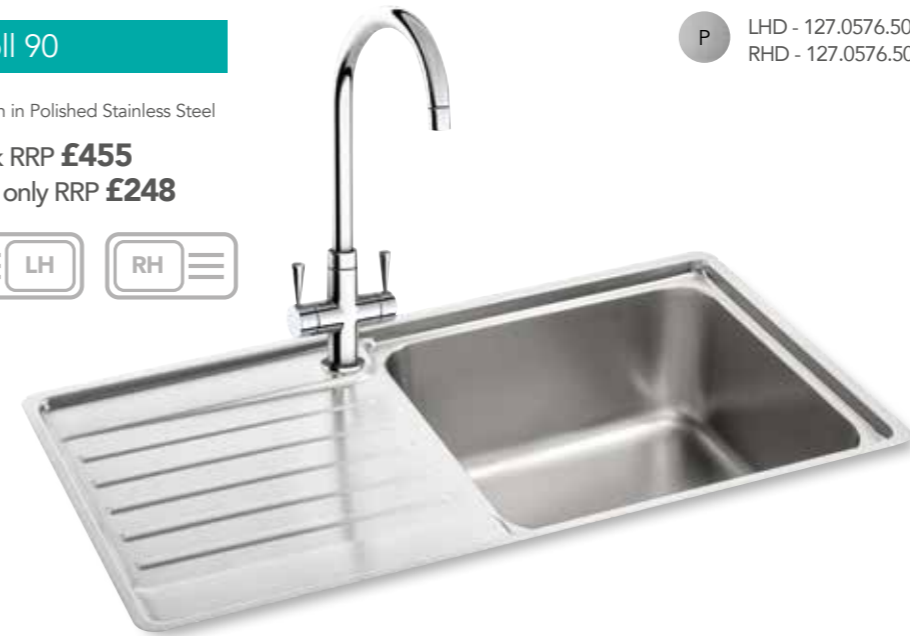

P LHD - 127.0576.501  
RHD - 127.0576.502

DIMENSIONS	Left to Right: 860mm Front to Back: 480mm
BOWL DIMENSIONS	Left to Right: 420mm Front to Back: 415mm
BOWL DEPTH	200mm
CUT OUT DIMENSIONS	Left to Right: 837mm Front to Back: 457mm
MINIMUM CABINET	600mm

OTHER – Suitable for WDU – Yes  
Revolution Waste included

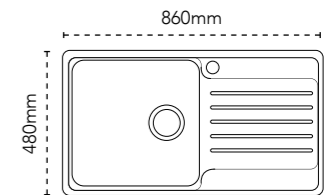

### Atoll 150

Shown in Polished Stainless Steel

Pack RRP **£516**  
Sink only RRP **£309**



P LHD - 127.0576.503  
RHD - 127.0576.504

DIMENSIONS	Left to Right: 1000mm Front to Back: 480mm
1ST BOWL DIMENSIONS	Left to Right: 360mm Front to Back: 415mm
2ND BOWL DIMENSIONS	Left to Right: 170mm Front to Back: 320mm
BOWL DEPTH	200mm/130mm
CUT OUT DIMENSIONS	Left to Right: 1014mm Front to Back: 484mm
MINIMUM CABINET	600mm

OTHER – Suitable for WDU – In main bowl only  
Revolution Waste included

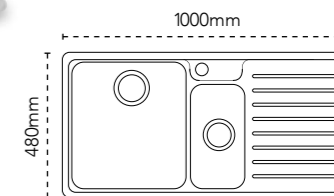

# RAPID

Our Rapid range offers classic curves and a modern appearance, available in a brushed chrome finish.

Sinks shown with Henley tap  
Henley tap Chrome - 115.0254.448

## Rapid 90

Shown in Brushed Chrome

Pack RRP **£403**  
Sink only RRP **£196**



B 101.0495.180

DIMENSIONS	Left to Right: 860mm Front to Back: 500mm
BOWL DIMENSIONS	Left to Right: 340mm Front to Back: 400mm
BOWL DEPTH	190mm
CUT OUT DIMENSIONS	Left to Right: 840mm Front to Back: 480mm
MINIMUM CABINET	500mm

OTHER – Suitable for WDU – Yes  
Standard Waste included

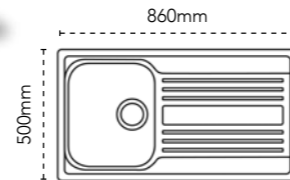

## Rapid 150

Shown in Brushed Chrome

Pack RRP **£485**  
Sink only RRP **£278**



B 101.0495.211

DIMENSIONS	Left to Right: 1000mm Front to Back: 500mm
BOWL DIMENSIONS	Left to Right: 340mm Front to Back: 400mm
2ND BOWL DIMENSIONS	Left to Right: 160mm Front to Back: 300mm
BOWL DEPTH	190mm/120mm
CUT OUT DIMENSIONS	Left to Right: 980mm Front to Back: 480mm
MINIMUM CABINET	600mm

OTHER – Suitable for WDU – In main bowl only  
Revolution Waste included

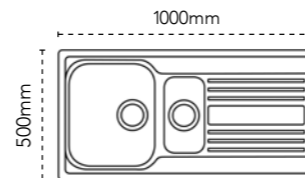

Upgrade  
to your  
ideal tap!

See our taps range  
on pages 46 - 55

Rapid 150 with Zeno tap in Chrome



# ONDA

Our Onda sinks offer excellent value for money whilst combining good looks with high performance and durability.

**Upgrade to your ideal tap!**

See our taps range on pages 46 - 55

**Upgrade to your ideal tap!**

See our taps range on pages 46 - 55

Sinks shown with Henley tap  
Henley tap Chrome - 115.0254.448

Sinks shown with Henley tap  
Henley tap Chrome - 115.0254.448

## Onda 90

Shown in Polished Stainless Steel

Pack RRP **£352**  
Sink only RRP **£145**



P 101.0488.562

DIMENSIONS	Left to Right: 860mm Front to Back: 500mm
BOWL DIMENSIONS	Left to Right: 345mm Front to Back: 395mm
BOWL DEPTH	160mm
CUT OUT DIMENSIONS	Left to Right: 840mm Front to Back: 480mm
MINIMUM CABINET	450mm

OTHER – Suitable for WDU – Yes  
Standard Waste included

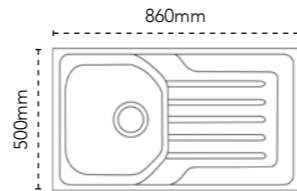

## Onda 100

Shown in Polished Stainless Steel

Pack RRP **£371**  
Sink only RRP **£164**



P 101.0488.563

DIMENSIONS	Left to Right: 1000mm Front to Back: 500mm
BOWL DIMENSIONS	Left to Right: 450mm Front to Back: 395mm
BOWL DEPTH	160mm
CUT OUT DIMENSIONS	Left to Right: 980mm Front to Back: 480mm
MINIMUM CABINET	600mm

OTHER – Suitable for WDU – Yes  
Standard Waste included

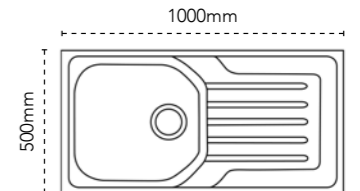

## Onda 150

Shown in Polished Stainless Steel

Pack RRP **£400**  
Sink only RRP **£193**



P 101.0488.564

DIMENSIONS	Left to Right: 1000mm Front to Back: 500mm
1ST BOWL DIMENSIONS	Left to Right: 345mm Front to Back: 395mm
2ND BOWL DIMENSIONS	Left to Right: 160mm Front to Back: 320mm
BOWL DEPTH	160mm/80mm
CUT OUT DIMENSIONS	Left to Right: 980mm Front to Back: 480mm
MINIMUM CABINET	600mm

OTHER – Suitable for WDU – Yes  
Standard Waste included

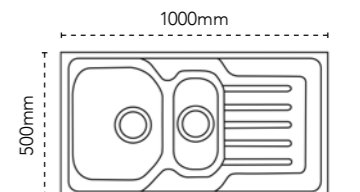

Onda 150 with Dante tap in Chrome



# DECA INSET / UNDERMOUNT

Deca is a superb example of minimalist practicality and style, featuring a 12mm bowl corner radii across all models. Each Deca model can be installed either as an inset or undermount.

Upgrade to your ideal tap!

See our taps range on pages 46 - 55

Upgrade to your ideal tap!

See our taps range on pages 46 - 55

Sinks shown with Henley tap  
Henley tap Chrome - 115.0254.448

Sinks shown with Henley tap  
Henley tap Chrome - 115.0254.448

## Deca 100

Shown in Polished Stainless Steel  
Shown inset

Pack RRP **£737**  
Sink only RRP **£530**



P 127.0442.744

ACCESSORY **£40** - 112.0018.988



DIMENSIONS	Left to Right: 400mm Front to Back: 450mm
BOWL DIMENSIONS	Left to Right: 360mm Front to Back: 410mm
BOWL DEPTH	200mm
CUT OUT DIMENSIONS (inset only)	Use template to u/mount Left to Right: 370mm Front to back: 420mm
MINIMUM CABINET	450mm

OTHER – Suitable for WDU – Yes  
Revolution Waste included

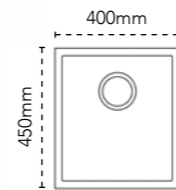

## Deca 105

Shown in Polished Stainless Steel  
Shown inset

Pack RRP **£778**  
Sink only RRP **£571**



P 127.0442.745

ACCESSORY **£61** - 112.0178.435



DIMENSIONS	Left to Right: 540mm Front to Back: 450mm
BOWL DIMENSIONS	Left to Right: 500mm Front to Back: 410mm
BOWL DEPTH	200mm
CUT OUT DIMENSIONS (inset only)	Use template to u/mount Left to Right: 510mm Front to back: 420mm
MINIMUM CABINET	550mm

OTHER – Suitable for WDU – Yes  
Revolution Waste included

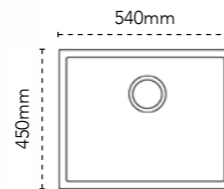

## Deca 150

Shown in Polished Stainless Steel  
Shown inset

Pack RRP **£1006**  
Sink only RRP **£799**



P LHSB - 127.0442.746  
RHSB - 127.0442.747

ACCESSORY **£40** - 112.0018.988



DIMENSIONS	Left to Right: 560mm Front to Back: 450mm
1ST BOWL DIMENSIONS	Left to Right: 340mm Front to Back: 410mm
2ND BOWL DIMENSIONS	Left to Right: 160mm Front to Back: 410mm
BOWL DEPTH	200mm/140mm
CUT OUT DIMENSIONS (inset only)	Use template to u/mount Left to Right: 530mm Front to Back: 420mm
MINIMUM CABINET	600mm

OTHER – Suitable for WDU – Yes  
Revolution Waste included

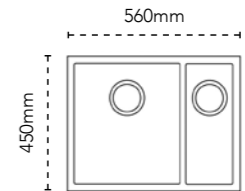

## Deca XL

Shown in Polished Stainless Steel  
Shown inset

Pack RRP **£804**  
Sink only RRP **£597**



P 127.0437.219

DIMENSIONS	Left to Right: 725mm Front to Back: 450mm
BOWL DIMENSIONS	Left to Right: 685mm Front to Back: 410mm
BOWL DEPTH	200mm
CUT OUT DIMENSIONS (Inset only)	Use template to u/mount Left to Right: 695mm Front to Back: 420mm
MINIMUM CABINET	800mm

OTHER – Suitable for WDU – Yes  
Revolution Waste included

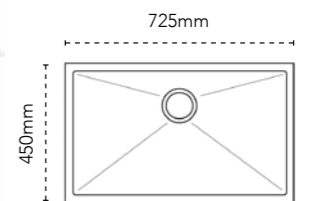



Deca 150 with Dante tap in Chrome

# ZETA UNDERMOUNT

Zeta's undermount models include the Zeta 150U, the first reversible installation undermount in our range.

Upgrade to your ideal tap!

See our taps range on pages 46 - 55

Sinks shown with Henley tap  
Henley tap Chrome - 115.0254.448

## Zeta 105U/50U

Shown in Polished Stainless Steel

105U Pack RRP **£550**  
105U Sink only RRP **£343**

50U Pack RRP **£438**  
50U Sink only RRP **£231**

P 105U - 122.0167.719  
50U - 122.0167.705

ACCESSORY **£42** - 112.0070.876



Wire Basket

105U 50U

DIMENSIONS	Left to Right: 494mm Front to Back: 464mm	205mm 365mm
BOWL DIMENSIONS	Left to Right: 450mm Front to Back: 420mm	170mm 320mm
BOWL DEPTH	200mm	130mm
CUT OUT DIMENSIONS	Use template	Use template
MINIMUM CABINET	500mm	300mm

OTHER - Suitable for WDU - Yes  
Standard Waste included

OTHER - Suitable for WDU - No  
Standard Waste included

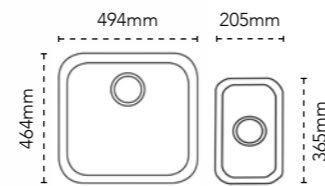

# IBIS UNDERMOUNT

The appeal of Ibis lies in its absolute simplicity. Clean lines and contemporary styling are echoed throughout the Ibis range.

Upgrade to your ideal tap!

See our taps range on pages 46 - 55

Sinks shown with Henley tap  
Henley tap Chrome - 115.0254.448

## Ibis 100U

Shown in Polished Stainless Steel

Pack RRP **£467**  
Sink only RRP **£260**

P 122.0281.513

DIMENSIONS	Left to Right: 400mm Front to Back: 460mm
BOWL DIMENSIONS	Left to Right: 360mm Front to Back: 420mm
BOWL DEPTH	200mm
CUT OUT DIMENSIONS	Use template
MINIMUM CABINET	400mm

OTHER - Suitable for WDU - Yes  
Revolution Waste included

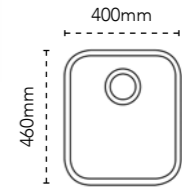

## Zeta 150U

Shown in Polished Stainless Steel

Pack RRP **£611**  
Sink only RRP **£404**



P 122.0167.720

ACCESSORY **£42** - 112.0070.876



Wire Basket

DIMENSIONS	Left to Right: 600mm Front to Back: 465mm
1ST BOWL DIMENSIONS	Left to Right: 360mm Front to Back: 420mm
2ND BOWL DIMENSIONS	Left to Right: 170mm Front to Back: 320mm
BOWL DEPTH	180mm/130mm
CUT OUT DIMENSIONS	Use template
MINIMUM CABINET	600mm

OTHER - Suitable for WDU - In main bowl only  
Standard Waste included

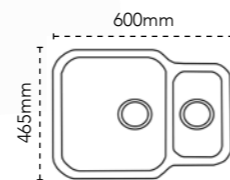

## Ibis 150U

Shown in Polished Stainless Steel

Pack RRP **£640**  
Sink only RRP **£433**



P LHSB - 122.0284.072  
RHSB - 122.0284.074

DIMENSIONS	Left to Right: 600mm Front to Back: 465mm
1ST BOWL DIMENSIONS	Left to Right: 360mm Front to Back: 420mm
2ND BOWL DIMENSIONS	Left to Right: 170mm Front to Back: 320mm
BOWL DEPTH	180mm /130mm
CUT OUT DIMENSIONS	Use template
MINIMUM CABINET	600mm

OTHER - Suitable for WDU - Yes  
Revolution Waste included

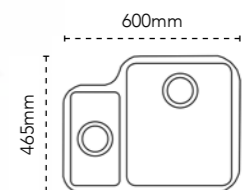



Upgrade  
to your  
ideal tap!

See our taps range  
on pages 46 - 55

Ibis 150U  
with Reno tap  
in Stone Grey

## CARISMA INSET / UNDERMOUNT

Carisma brings together sound design that makes this range a practical and durable choice.

Sinks shown with Henley tap  
Henley tap Chrome - 115.0254.448

### Carisma 400 UPDATED

Shown in Polished Stainless Steel

Pack RRP **£405**  
Sink only RRP **£198**



P 101.0694.342

DIMENSIONS	Left to Right: 435mm Front to Back: 435mm
BOWL DIMENSIONS	Diameter: 378.8mm
BOWL DEPTH	170mm
CUT OUT DIMENSIONS	Diameter: 415mm
MINIMUM CABINET	450mm

OTHER – Suitable for WDU – Yes  
Standard Waste included

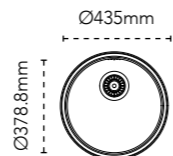

## CERAMIC



WHITE



Ceramic is a respected classic.

With its lustrous glossy glaze, a Ceramic sink combines beauty with distinction.



Each Carron Phoenix sink is supported by a **Lifetime Guarantee** against manufacturing defects.

Ceramic is a hard-working, non-porous surface that is easy to clean and extremely resistant to heat and chemicals.

Our Ceramic sinks are traditionally manufactured from fine-fireclay that is fired at high temperatures and then individually finished by hand. This ensures their fine quality with a true depth of colour and an impeccable smooth surface.

# SIENNA

The Sienna is a stylish and classic Ceramic sink, suited to both traditional and more contemporary kitchens.

Sinks shown with Henley tap  
Henley tap Chrome - 115.0254.448

Upgrade  
to your  
ideal tap!

See our taps range  
on pages 46 - 55

## Sienna 100

Shown in White

Pack RRP **£591**  
Sink only RRP **£384**



WH 124.0188.034

DIMENSIONS	Left to Right: 1010mm Front to Back: 530mm
BOWL DIMENSIONS	Left to Right: 410mm Front to Back: 455mm
BOWL DEPTH	210mm
CUT OUT DIMENSIONS	Use template
MINIMUM CABINET	600mm (40mm Worktop) 1000mm (30mm Worktop)

OTHER – Suitable for WDU – No  
Standard Waste included

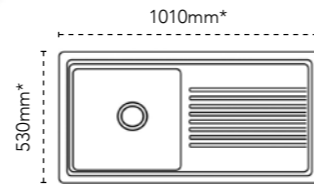

Please note:  
An extended flange is  
required if fitting a WDU  
to this Ceramic sink.

\*Ceramic sink dimensions may vary  
± 2% due to firing process.

## Sienna 150

Shown in White

Pack RRP **£602**  
Sink only RRP **£395**



WH 124.0188.036

DIMENSIONS	Left to Right: 1010mm Front to Back: 525mm
1ST BOWL DIMENSIONS	Left to Right: 410mm Front to Back: 325mm
2ND BOWL DIMENSIONS	Left to Right: 170mm Front to Back: 160mm
BOWL DEPTH	210mm/120mm
CUT OUT DIMENSIONS	Use template
MINIMUM CABINET	600mm (40mm Worktop) 1000mm (30mm Worktop)

OTHER – Suitable for WDU – Yes  
Standard Waste included

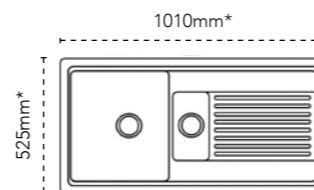

Please note:  
An extended flange is  
required if fitting a WDU  
to this Ceramic sink.

\*Ceramic sink dimensions may vary  
± 2% due to firing process.

# SHONELLE

Shonelle offers a contemporary interpretation of the classic Ceramic sink. Each of the models balances stylish good looks with practical ergonomics and offers design versatility for contemporary kitchens.

Sinks shown with Henley tap  
Henley tap Chrome - 115.0254.448

Upgrade  
to your  
ideal tap!

See our taps range  
on pages 46 - 55

## Shonelle 105

Shown in White

Pack RRP **£625**  
Sink only RRP **£418**



WH 124.0477.792

DIMENSIONS	Left to Right: 920mm Front to Back: 510mm
BOWL DIMENSIONS	Left to Right: 410mm Front to Back: 410mm
BOWL DEPTH	220mm
CUT OUT DIMENSIONS	Use template
MINIMUM CABINET	600mm

OTHER – Suitable for WDU – Yes  
Standard Waste included

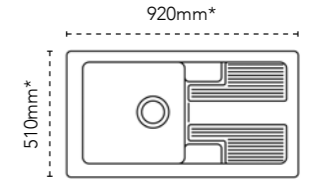

Please note:  
An extended flange is  
required if fitting a WDU  
to this Ceramic sink.

\*Ceramic sink dimensions may vary  
± 2% due to firing process.

## Shonelle 150

Shown in White

Pack RRP **£641**  
Sink only RRP **£434**



WH 124.0477.793

DIMENSIONS	Left to Right: 1010mm Front to Back: 510mm
1ST BOWL DIMENSIONS	Left to Right: 360mm Front to Back: 420mm
2ND BOWL DIMENSIONS	Left to Right: 130mm Front to Back: 260mm
BOWL DEPTH	220mm/120mm
CUT OUT DIMENSIONS	Use template
MINIMUM CABINET	600mm

OTHER – Suitable for WDU – Yes  
Standard Waste included

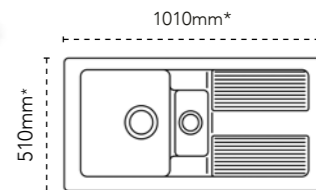

Please note:  
An extended flange is  
required if fitting a WDU  
to this Ceramic sink.

\*Ceramic sink dimensions may vary  
± 2% due to firing process.



**Upgrade to your ideal tap!**

See our taps range on pages 46 - 55

**Upgrade to your ideal tap!**

See our taps range on pages 46 - 55

## BELFAST

Belfast sinks bring together classic styling and good old-fashioned charm, yet they fit well with contemporary and traditional kitchens alike. Our single bowl Belfast sink is available with either a traditional weir or a more modern integrated overflow.

Sinks shown with Henley tap  
Henley tap Chrome - 115.0254.448

### Belfast 100

Shown in White

Pack RRP **£625**  
Sink only RRP **£418**



WH 124.0477.726

DIMENSIONS	Left to Right: 595mm Front to Back: 475mm
OVERALL HEIGHT	220mm
BOWL DIMENSIONS	Left to Right: 550mm Front to Back: 420mm
BOWL DEPTH	220mm
CUT OUT DIMENSIONS	Use sink as template
MINIMUM CABINET	600mm

OTHER – Suitable for WDU – Yes  
Standard Waste included

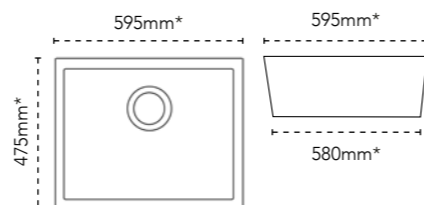

Please note:  
An extended flange is required if fitting a WDU to this Ceramic sink.

\*Ceramic sink dimensions may vary ± 2% due to firing process.

### Belfast 110

Shown in White

Pack RRP **£625**  
Sink only RRP **£418**



WH 124.0477.727

DIMENSIONS	Left to Right: 595mm Front to Back: 455mm
OVERALL HEIGHT	250mm
BOWL DIMENSIONS	Left to Right: 525mm Front to Back: 385mm
BOWL DEPTH	215mm
CUT OUT DIMENSIONS	Use sink as template
MINIMUM CABINET	600mm

OTHER – Suitable for WDU – No  
Mini Waste included

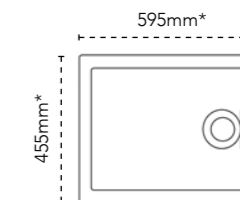

\*Ceramic sink dimensions may vary ± 2% due to firing process.

### Belfast 200

Shown in White

Pack RRP **£813**  
Sink only RRP **£606**



WH 124.0477.749

DIMENSIONS	Left to Right: 800mm Front to Back: 490mm
OVERALL HEIGHT	220mm
1ST BOWL DIMENSIONS	Left to Right: 365mm Front to Back: 450mm
2ND BOWL DIMENSIONS	Left to Right: 365mm Front to Back: 450mm
BOWL DEPTH	200mm
CUT OUT DIMENSIONS	Use sink as template
MINIMUM CABINET	800mm

OTHER – Suitable for WDU – Yes  
Standard Waste included

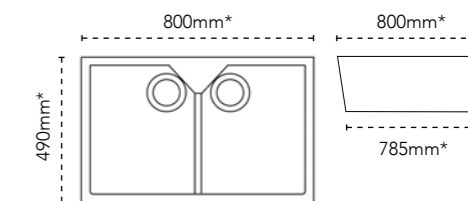

Please note:  
An extended flange is required if fitting a WDU to this Ceramic sink.

\*Ceramic sink dimensions may vary ± 2% due to firing process.

# CARLOW

The Carlow range offers an exceptional crossover between classic Ceramic and the modern method of undermounting. The soft lines in each model are complemented by the crisp white Ceramic.

Sinks shown with Henley tap  
Henley tap Chrome - 115.0254.448

## Carlow 105

Shown in White

Pack RRP **£597**  
Sink only RRP **£390**



WH 126.0659.184

ACCESSORY **£42** - 112.0070.876



Wire Basket

DIMENSIONS	Left to Right: 545mm Front to Back: 440mm
BOWL DIMENSIONS	Left to Right: 492mm Front to Back: 388mm
BOWL DEPTH	176mm
CUT OUT DIMENSIONS	Use sink as template
MINIMUM CABINET	600mm

OTHER – Suitable for WDU – Yes  
Revolution Waste included

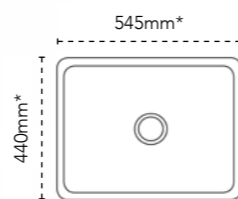

Please note:  
An extended flange is required if fitting a WDU to this Ceramic sink.

\*Ceramic sink dimensions may vary ± 2% due to firing process.

## Carlow 150

Shown in White

Pack RRP **£724**  
Sink only RRP **£517**



WH 126.0659.185

ACCESSORY **£40** - 112.0018.988



Wire Basket

DIMENSIONS	Left to Right: 490mm Front to Back: 440mm
1ST BOWL DIMENSIONS	Left to Right: 335mm Front to Back: 390mm
2ND BOWL DIMENSIONS	Left to Right: 145mm Front to Back: 280mm
BOWL DEPTH	180mm / 120mm
CUT OUT DIMENSIONS	Use sink as template
MINIMUM CABINET	600mm

OTHER – Suitable for WDU – In main bowl only  
Revolution Waste included

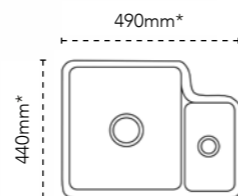

Please note:  
An extended flange is required if fitting a WDU to this Ceramic sink.

\*Ceramic sink dimensions may vary ± 2% due to firing process.

# WATERFORD INSET / UNDERMOUNT

Echoing the plain and simple design of a Belfast sink, the Waterford range of sinks can be installed as inset sinks or they can be undermounted.

Sinks shown with Henley tap  
Henley tap Chrome - 115.0254.448

## Waterford 50/100

Shown in White  
Shown undermounted

50 Pack RRP **£523**  
50 Sink only RRP **£316**

100 Pack RRP **£555**  
150 Sink only RRP **£348**

WH 50 - 124.0477.750  
100 - 124.0477.791



## Waterford 100

## Waterford 50

DIMENSIONS	Left to Right: 450mm Front to Back: 475mm	Left to Right: 250mm Front to Back: 475mm
BOWL DIMENSIONS	Left to Right: 380mm Front to Back: 405mm	Left to Right: 180mm Front to Back: 405mm
BOWL DEPTH	180mm	130mm
CUT OUT DIMENSIONS	Use sink as template	Use sink as template
MINIMUM CABINET	500mm	300mm

OTHER – Suitable for WDU – Yes  
Standard Waste included

OTHER – Suitable for WDU – No  
Standard Waste included

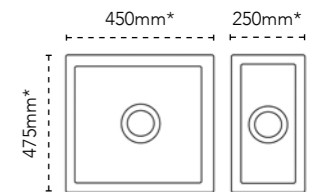

Please note:  
An extended flange is required if fitting a WDU to this Ceramic sink.

\*Ceramic sink dimensions may vary ± 2% due to firing process.



# TAPS



Our tap range has been specially designed to give you all the options you need to complement your Carron Phoenix sink.

Whether you are looking for a contemporary, traditional or designer style, single or double lever operation, or even a boiling water or filter tap, we have a selection of high quality and attractive taps for you to choose from.

Depending on the style and age of your house, you may require a specific style of tap, a model that is appropriate to the water pressure available in your kitchen. Specifically, many older properties will require a tap which has been designed to work best with lower water pressure or gravity fed systems. So, if you know your property has low water pressure, choose a tap suitable for low pressure systems. If you have a high pressure system you can choose any tap. See the icon below next to tap of your choice for the recommended water pressure needed.



Each Carron Phoenix mixer tap is supported by a **Five year comprehensive Guarantee** against manufacturing defects.

**Household water pressures**  
(minimum tap flow rating)



**Did you know?**  
100°C can sterilise baby bottles!

## SERAPHINA 3-in-1 Boiling Water Tap

CH 119.0285.777  
RRP **£1056**



The Seraphina 3-in-1 Boiling Water tap provides instant boiling water (100°C) at the touch of a button. Seraphina provides normal hot and cold water as well as boiling water, all from the same unit.



### TAP DIMENSIONS

Tap Height:	363mm
Base Width:	60mm
Spout Height:	259mm
Spout Reach:	216mm
Finish:	Chrome

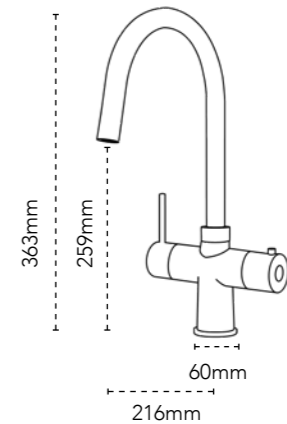

Why waste electricity and water when boiling the kettle when you can have instant boiling water for making coffee, tea or for cooking on tap?

Seraphina incorporates a water conditioning filter, ensuring your boiling water is free from sediment, odour and any unwanted particles. Seraphina requires the activation of a safety button to operate the boiling water function, ensuring the safety of users.

In addition to the tap and the filter, the Seraphina system includes a 4.7 litre heating tank which can be situated horizontally behind a standard 150mm high cabinet plinth. This unique feature frees up the cabinet space underneath the sink for a very practical solution.

### IMPORTANT

Please be aware of your water pressure before purchase. If your water pressure is too low, the installation of a pump should be investigated. If your pressure is too high, the inclusion of a pressure reducing valve (not supplied) in the system will be necessary.

Operating pressures: 1.5 to 5 bar.



# FILTER TAPS



Desirable, stylish and highly practical, Carron Phoenix Filter taps dispense hot, cold and perfectly filtered water.

Combining the considered elegance of our most stylish designs with technologically advanced water filtration, Carron Phoenix taps are the ultimate combination of fashion and functionality.

## DANTE TRI-PURE

Dante Tri-Pure Filter offers excellent filtration performance thanks to its double filtration system of charcoal and ceramics specially impregnated with silver particles.

The filter removes unwanted chlorine, cryptosporidium and other harmful bacteria and particles, yet leaving you with the minerals that are good for you.

CH 120.0193.061  
RRP **£579**



### TAP DIMENSIONS

Tap Height: 390mm  
Base Width: 60mm  
Spout Height: 260mm  
Spout Reach: 220mm  
Finish: Chrome

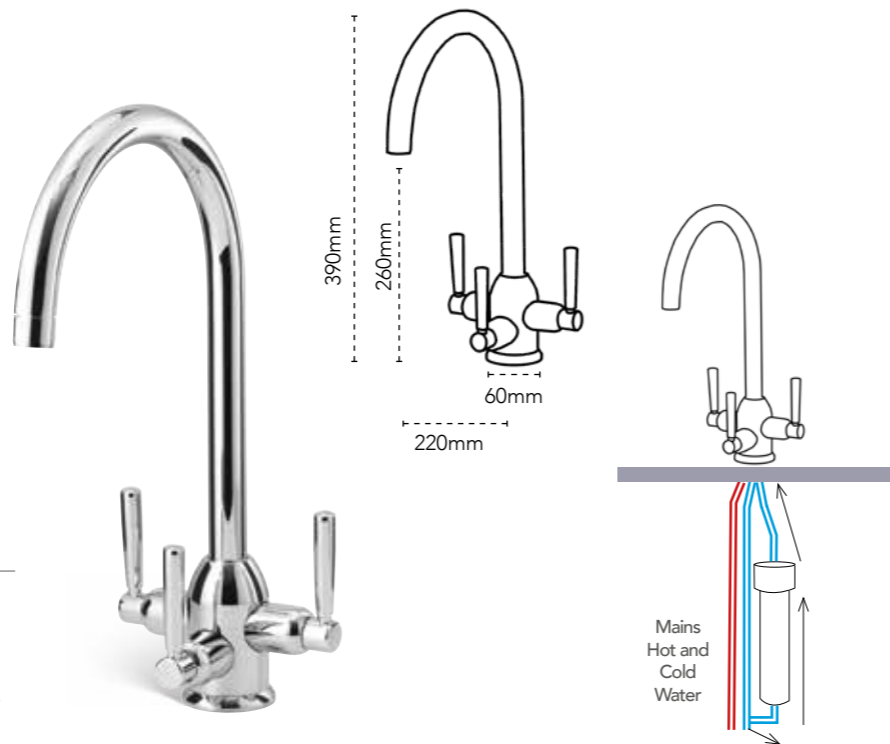

## SIFT FILTER

Add a touch of class to your kitchen with the Sift filtered water tap. Available in 2 colours, this graceful swan neck tap boasts modern styling and is the only tap in the filtered range which comes in a matt black finish.

The limescale reduction filter system improves the taste of the water, whilst also reducing limescale, odour and sediment.



CH 120.0608.887  
RRP **£362**

MB 120.0608.961  
RRP **£417**

### TAP DIMENSIONS

Tap Height: 397mm  
Base Width: 48mm  
Spout Height: 272mm  
Spout Reach: 216mm  
Finish: Chrome  
Decor Steel  
Matt Black

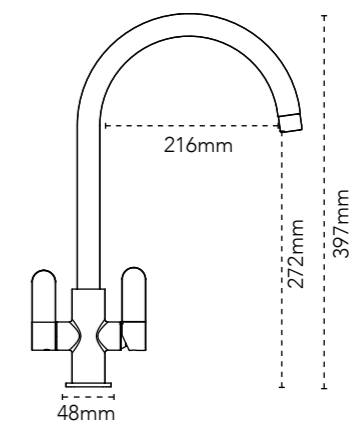

# MIXER TAPS



A comprehensive selection of precision-made taps to complement your Carron Phoenix sink, available in a number of styles and finishes to suit your own personal taste.

## Bali

CH 115.0193.014  
RRP **£377**

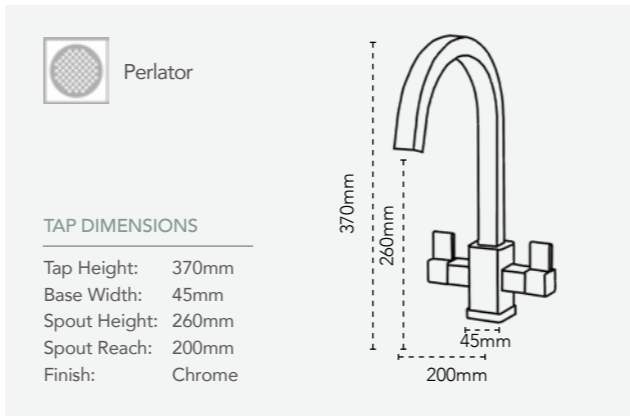

## Dante Pro

### Pull-Out Nozzle

CH 115.0191.084  
RRP **£373**

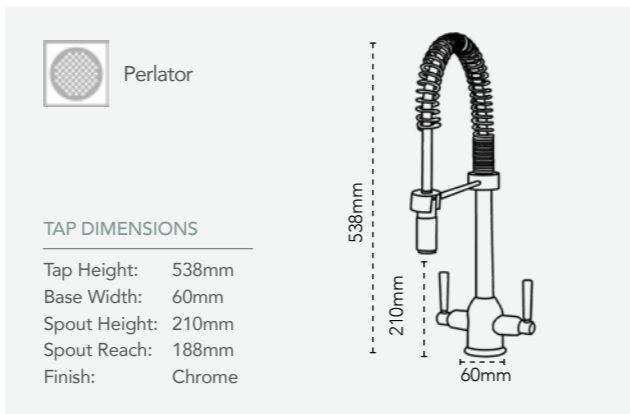

## Dante Pull-Out

### Pull-Out Spray

CH B 115.0433.945  
RRP **£373**

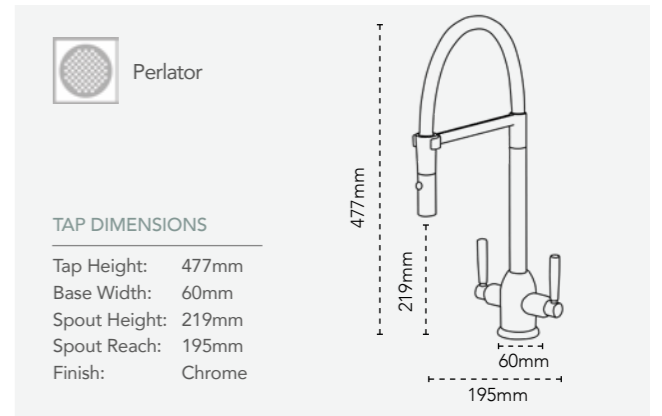

## Ardenza

CH 115.0605.463  
RRP **£366**

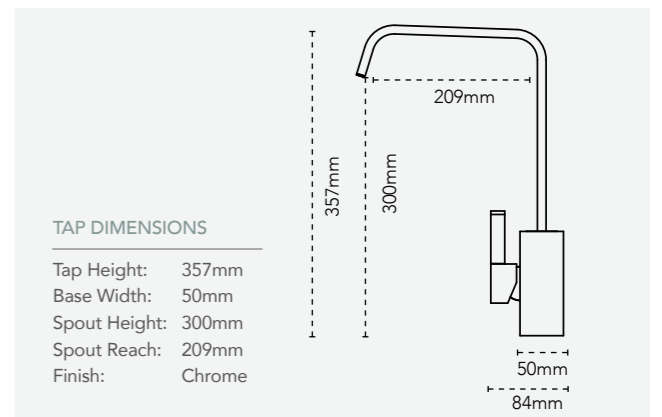

## Barra

CH 115.0074.732  
RRP **£328**

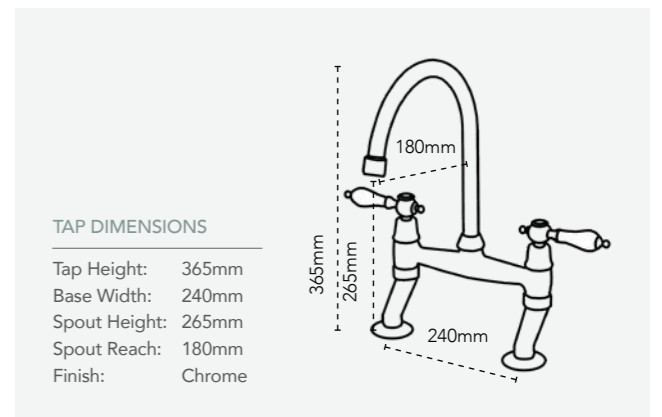

## Rosolina L Spout

CH 115.0605.455  
RRP **£324**

MB 115.0605.457  
RRP **£354**

NEW FINISH BR 115.0689.773  
RRP **£421**

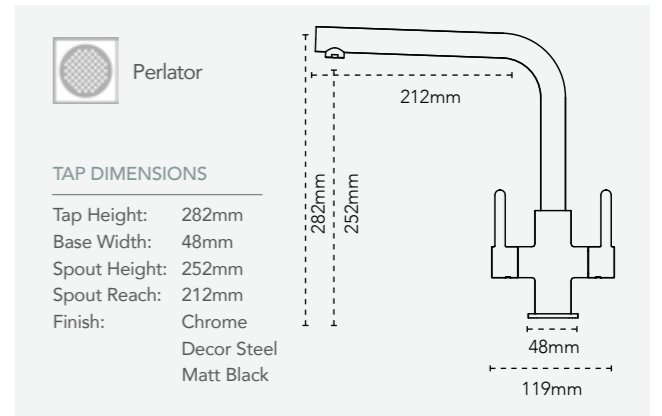

## Dante

CH 115.0068.382  
RRP **£300**

DS 115.0068.384  
RRP **£313**



Perlator

### TAP DIMENSIONS

Tap Height: 390mm  
Base Width: 60mm  
Spout Height: 260mm  
Spout Reach: 220mm  
Finish: Chrome  
Decor Steel

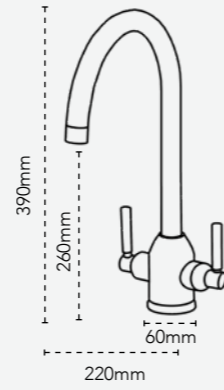

## Opus

CH 115.0019.224  
RRP **£209**

DS 115.0019.236  
RRP **£255**

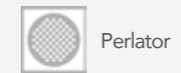

Perlator

### TAP DIMENSIONS

Tap Height: 300mm  
Base Width: 45mm  
Spout Height: 225mm  
Spout Reach: 160mm  
Finish: Chrome  
Decor Steel

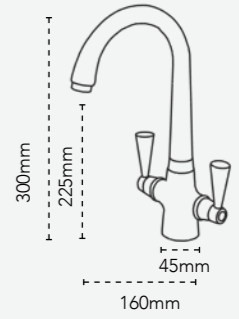

## Reno

CH 115.0029.805  
RRP **£288**

SG 115.0535.842  
RRP **£297**

ON 115.0189.492  
RRP **£297**

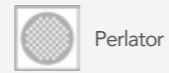

Perlator

### TAP DIMENSIONS

Tap Height: 257mm  
Base Width: 47mm  
Spout Height: 160mm  
Spout Reach: 181mm  
Finish: Chrome  
Stone Grey  
Onyx

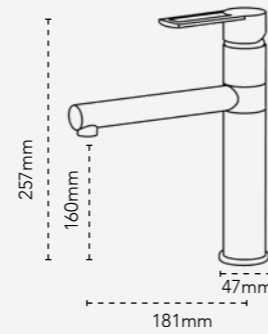

## Henley

CH 115.0254.448  
RRP **£207**

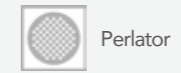

Perlator

### TAP DIMENSIONS

Tap Height: 363mm  
Base Width: 45mm  
Spout Height: 223mm  
Spout Reach: 194mm  
Finish: Chrome

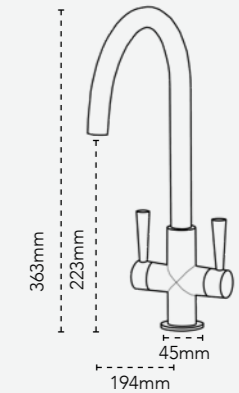

## Windsor

CH 115.0281.850  
RRP **£264**

**NEW FINISH** BR 115.0689.775  
RRP **£344**



### TAP DIMENSIONS

Tap Height: 343mm  
Base Width: 44mm  
Spout Height: 213mm  
Spout Reach: 194mm  
Finish: Chrome  
Brass

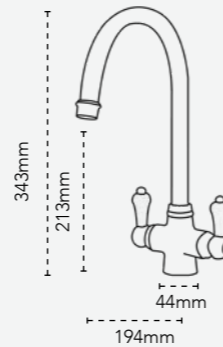

## Rosolina J Spout

CH 115.0074.732  
RRP **£324**

MB 115.0605.454  
RRP **£354**

**NEW FINISH** BR 115.0689.772  
RRP **£421**

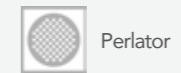

Perlator

### TAP DIMENSIONS

Tap Height: 356mm  
Base Width: 48mm  
Spout Height: 242mm  
Spout Reach: 215mm  
Finish: Chrome

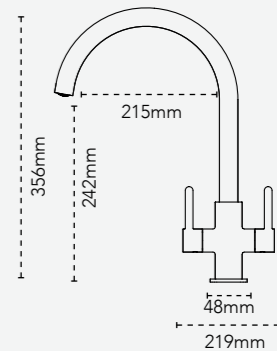

## Alba

CH 115.0068.379  
RRP **£239**

DS 115.0188.558  
RRP **£256**



Perlator

### TAP DIMENSIONS

Tap Height: 350mm  
Base Width: 50mm  
Spout Height: 220mm  
Spout Reach: 190mm  
Finish: Chrome  
Decor Steel

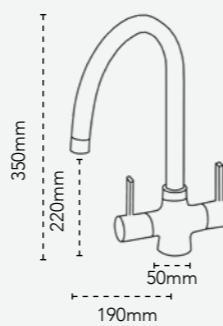

## Savoy

CH 115.0254.455  
RRP **£174**

DS 115.0605.451  
RRP **£186**

MB 115.0605.320  
RRP **£205**

**NEW FINISH** BR 115.0689.774  
RRP **£330**

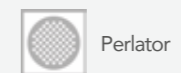

Perlator

### TAP DIMENSIONS

Tap Height: 384mm  
Base Width: 45mm  
Spout Height: 240mm  
Spout Reach: 189mm  
Finish: Chrome  
Decor Steel  
Matt Black  
Brass

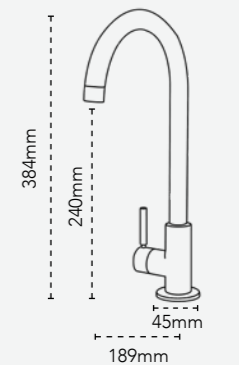



Rapid 150 with Zeno tap in Chrome

### Aztec

CH 115.0019.342  
RRP **£133**



#### TAP DIMENSIONS

Tap Height: 245mm  
Base Width: 45mm  
Spout Height: 210mm  
Spout Reach: 230mm  
Finish: Chrome

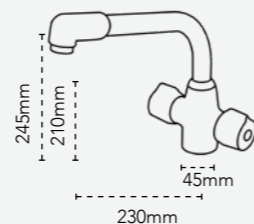

### Zeno

CH 115.0363.799  
RRP **£88**



#### TAP DIMENSIONS

Tap Height: 115mm  
Base Width: 44mm  
Spout Height: 210mm  
Spout Reach: 214mm  
Finish: Chrome

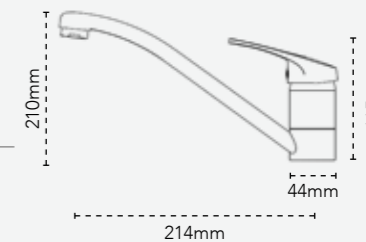

# WASTE MANAGEMENT

A quick, easy and efficient way to prevent organic waste going into landfill!



With the environment in mind, we have a range of waste management solutions that can help you dispose of your waste in a highly efficient and eco-friendly way.

## CARRONADE ELITE WASTE DISPOSAL UNITS

### Carronade Elite CE-50

134.0473.240  
RRP **£290**

An extended flange is available if required at extra cost when fitting to ceramic sinks

RRP **£47**



#### DIMENSIONS

Height: 354mm  
Width: 132mm

#### TECHNICAL SPECIFICATIONS

Horsepower: 1/2  
rpm: 2600  
Capacity: 600ml  
Operation: Continuous  
Power: Airswitch  
Sound insulation: Full  
Warranty: 3 Years

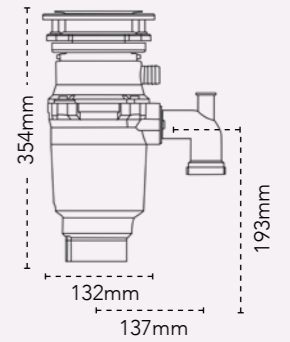

### Carronade Elite CE-75

134.0473.271  
RRP **£412**

An extended flange is available if required at extra cost when fitting to ceramic sinks

RRP **£47**



#### DIMENSIONS

Height: 386mm  
Width: 220mm

#### TECHNICAL SPECIFICATIONS

Horsepower: 3/4  
rpm: 2700  
Capacity: 800ml  
Operation: Continuous  
Power: Airswitch  
Sound insulation: Full  
Warranty: 10 Years

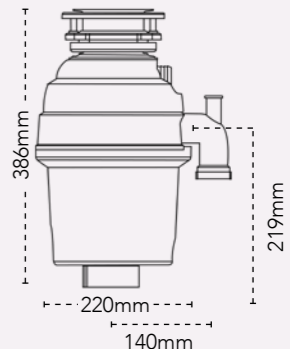

## Carronade Elite Waste Disposal Units

Waste disposal units are very easily installed with the current plumbing under your sink and are easy to operate.

Our premium specification products are sound insulated for a quiet operation, are septic safe and incredibly efficient. Carronade Elite waste disposal units are suitable for every day use. Food is fed into the disposer as it operates.

On/off control is operated by a separate air switch which is supplied.



## Waste Sorter Bins

Carron Phoenix waste sorter bins can be fitted easily into a kitchen cabinet and will help you to effectively segregate your waste prior to collection. With a range of configurations to choose from, each model features removable bin inserts and covers to contain odours.



## WASTE SORTER BINS

### Linea 130

134.0204.152  
RRP **£115**



#### DIMENSIONS

Height: 423mm  
Width: 253mm  
Depth: 467mm

#### TECHNICAL SPECIFICATIONS

Number of bins: 1  
Capacity: 1 x 30 litres  
Min. cabinet: 300mm  
Operation: Manual  
Warranty: 2 years

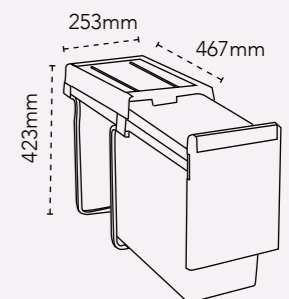

### Linea 230

134.0204.599  
RRP **£115**



#### DIMENSIONS

Height: 423mm  
Width: 253mm  
Depth: 467mm

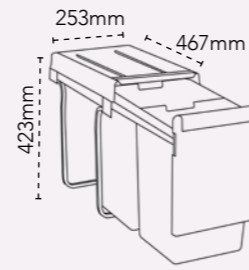

#### TECHNICAL SPECIFICATIONS

Number of bins: 2  
Capacity: 2 x 15 litres  
Min. cabinet: 300mm  
Operation: Manual  
Warranty: 2 years

### Linea 330

134.0204.153  
RRP **£115**



#### DIMENSIONS

Height: 423mm  
Width: 253mm  
Depth: 467mm

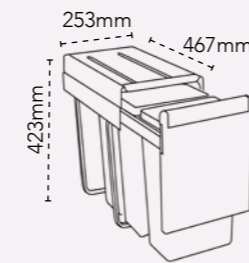

#### TECHNICAL SPECIFICATIONS

Number of bins: 3  
Capacity: 3 x 10 litres  
Min. cabinet: 300mm  
Operation: Manual  
Warranty: 2 years

### Linea 332

134.0074.068  
RRP **£145**



#### DIMENSIONS

Height: 340mm  
Width: 438mm  
Depth: 330mm

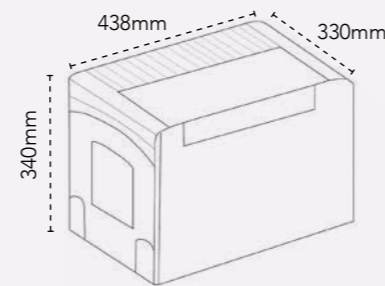

#### TECHNICAL SPECIFICATIONS

Number of bins: 3  
Capacity: 1 x 16 litres  
2 x 8 litres  
Min. cabinet: 500mm  
Operation: Manual  
Warranty: 2 years

### Linea 360

134.0079.062  
RRP **£230**



#### DIMENSIONS

Height: 423mm  
Width: 506mm  
Depth: 467mm

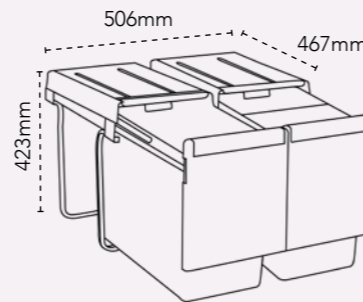

#### TECHNICAL SPECIFICATIONS

Number of bins: 3  
Capacity: 1 x 30 litres  
2 x 15 litres  
Min. cabinet: 300mm  
Operation: Manual  
Warranty: 2 years



**CARRON**  
PHOENIX



**CARRON**  
P H O E N I X

**Carron Phoenix**

Franke UK Ltd  
West Park, MIOC,  
Styal Road,  
Manchester  
M22 5WB

Tel: 0161 436 6280  
Email: [info@carron.com](mailto:info@carron.com)  
[www.carron.com](http://www.carron.com)

